

# Ancient Greek Technology

Alena Šolcová  
Dept. of Computer Science  
Faculty of Information Technology  
Czech Technical University in Prague

September 25, 2013

# Motto

Plato is my friend,  
Aristotle is my friend,  
But my greatest friend is truth.

MSAdd3996, 88r

Isaac Newton



# Ancient Greek technology

- Developed at an unprecedented speed during the 5th century BC, continuing up to and including the Roman period, and beyond.
- Inventions that are credited to the ancient Greeks such as the **gear, screw, rotary mills, screw press, bronze casting techniques, water clock, water organ, torsion catapult** and the use of steam to operate some experimental machines and toys.

# Greek Inventions

- Many of these inventions occurred late in the Greek period, often inspired by the **need to improve weapons and tactics in war**. However, peaceful uses are shown by their **early development of the watermill**, a device which pointed to further exploitation on a large scale under the Romans.
- They developed **surveying and mathematics** to an advanced state, and many of their technical advances were published by philosophers like **Archimedes and Hero**.

# Water technology

- One of the foundations for many modern technological achievements would include water resources.
- Some fields that were encompassed in the area of water resources (mainly for urban use), would include such areas as groundwater exploitation, construction of **aqueducts** for water supply, stormwater and wastewater sewerage systems, flood protection and drainage, construction and use of **fountains**, baths and other sanitary and purgatory facilities, and even recreational uses of water.

# Streets, ca. 400 BC

## **Example:** The **Porta Rosa**

(IV-III century BC)

was the main street of Elea (Italy).

- It connects the northern quarter with the southern quarter.
- The street is 5 meters wide and has an incline of 18 % in the steepest part.
- It is paved with limestone blocks, griders cut in square blocks, and on one side a small gutter for the drainage of rain water.



# Kartography

- ca. 600 BC

First widespread amalgamation of geographical maps developed by **Anaximander**.

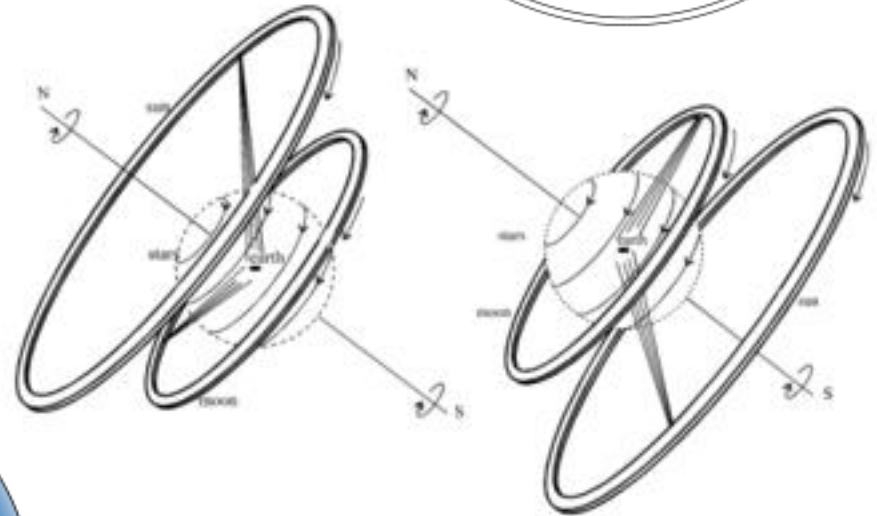
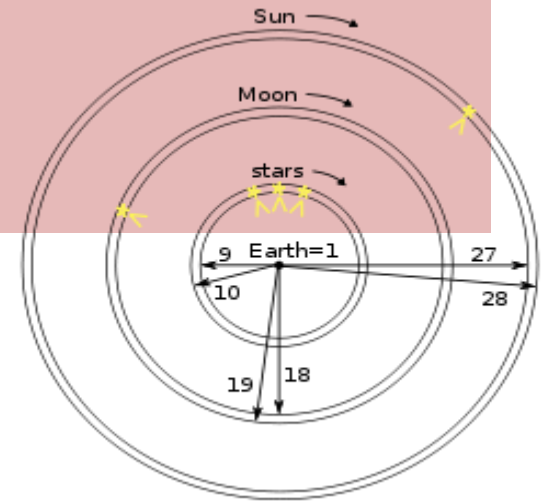
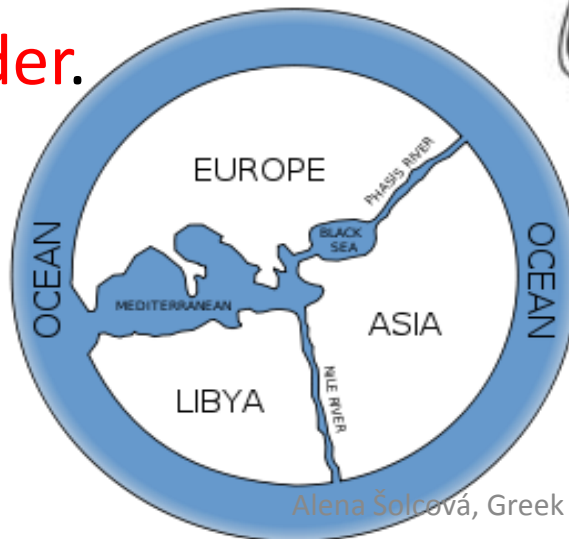

# Crane

- ca. 515 BC
- Labor-saving device which allowed the employment of small and efficient work teams on construction sites.
- Later winches were added for heavy weights.





# Escapement

- 3rd century BC
- Described by the Greek engineer **Philo of Byzantium** in his technical treatise *Pneumatics* (chapter 31) as part of a washstand automaton for guests washing their hands.
- Philon's comment that "**its construction is similar to that of clocks**" indicates that such escapements mechanism were already integrated in ancient water clocks.

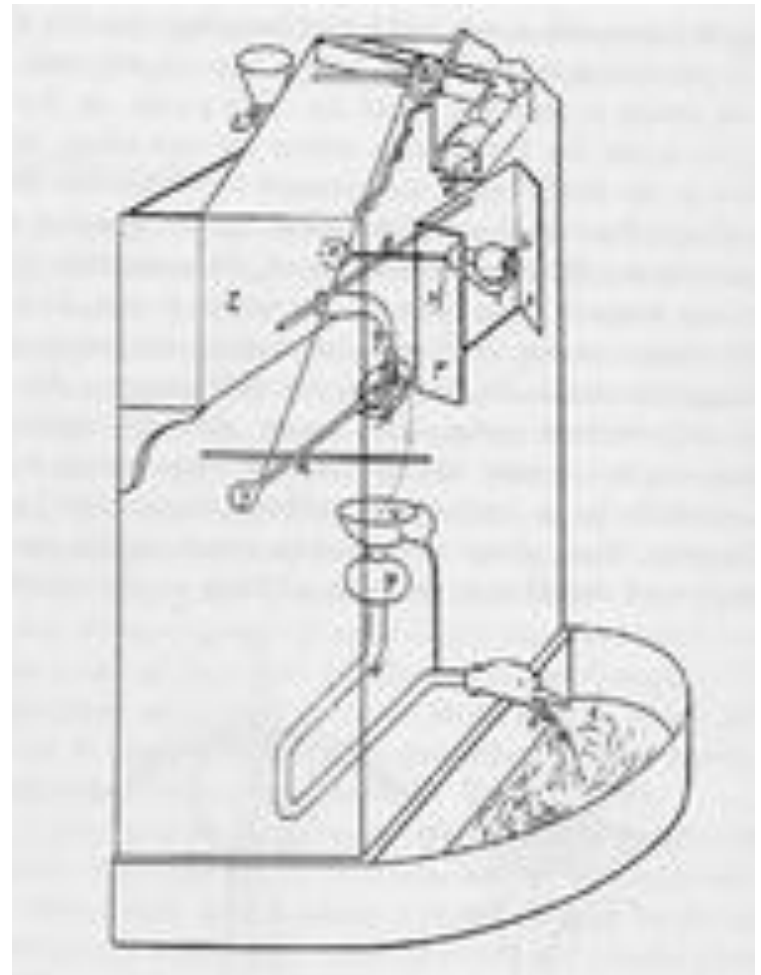

# Gears

- ca. 5th century BC
- Developed further than in prehistoric times for a variety of practical purposes.

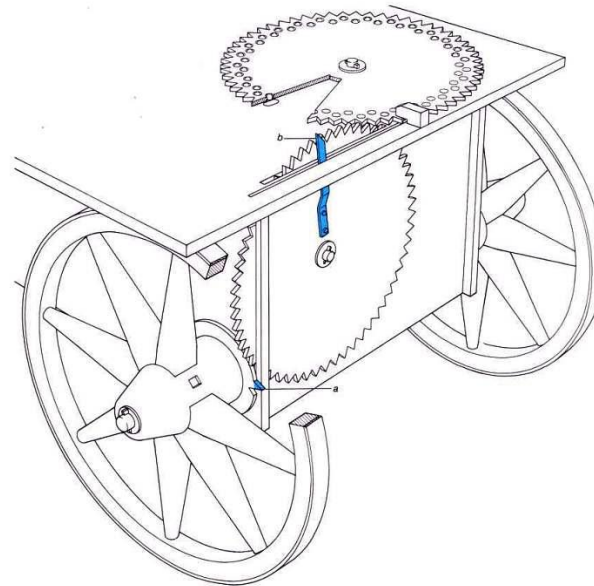

# Odometer



ca. 3rd c. BC

- **Odometer**, a device used in the late Hellenistic time and by Romans for indicating distance traveled by a vehicle was invented sometime in the 3rd century BC.

Some historians attribute it to **Archimedes**, others to **Hero of Alexandria**.

- It helped revolutionize the building of roads and travelling by them by accurately measuring distance and being able to illustrate this with a milestone.

# Clock

- A clock that each hour releases a small metallic sphere that falling inside a container produces a sound marking the start of a new hour.

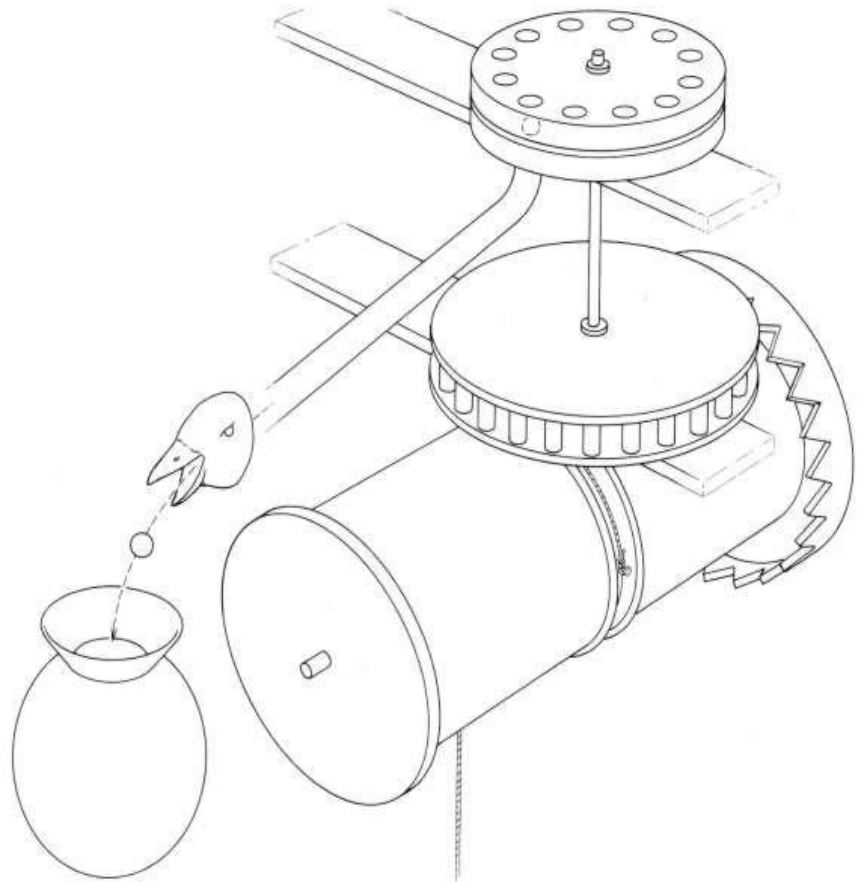

# Gears - 2

- **Aristotle** mentions gears around 330 BC, (wheel drives in windlasses). He said that the direction of rotation is reversed when one gear wheel drives another gear wheel.
- **Philon of Byzantium** was one of the first who used gears in water raising devices.
- **Archimedes** used gears in various constructions. Actually we have only indirect knowledge of his inventions. He did not publish any work describing his inventions.
- He viewed his mechanical inventions as amusements or as practical concerns of no scientific importance.

# Plutarch says:

- *"Although these inventions made his superhuman wisdom famous, he nonetheless wrote nothing on these matters because he felt that the construction of all machines and all devices for practical use in general was a low and ignoble business. He himself strove only to remove himself, by his handsomeness and perfection, far from the kingdom of necessity."*

# Levers

- ca. 260 BC
- First described about 260 BC by the ancient Greek mathematician **Archimedes**.
- Although used in prehistoric times,
- they were first put to practical use for more developed technologies in Ancient Greece.

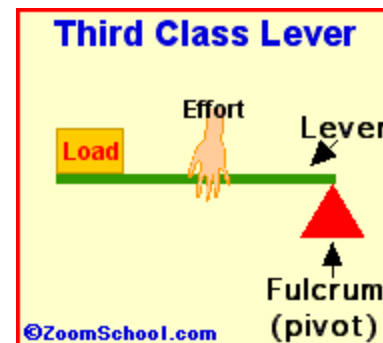
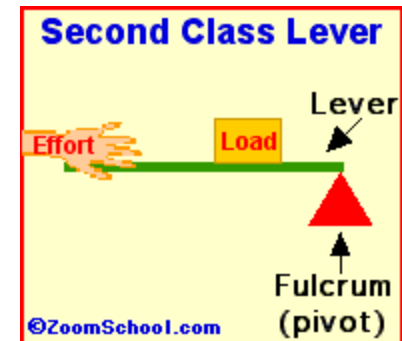
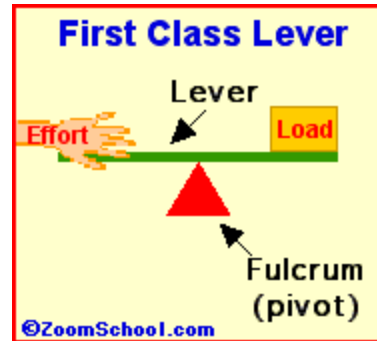

# Water mills

- ca. 250 BC
- The use of water power was pioneered by the Greeks
- The earliest mention of a water mill in history occurs in *Philo's Pneumatics*
- Previously been regarded as a later Arabic interpolation, but according to recent research to be of authentic Greek origin.

Model of a Roman water-powered grain-mill described by **Vitruvius**. The millstone (upper floor) is powered by a **undershot waterwheel** by the way of a gear mechanism (lower floor)





# Air and water pumps

ca. 2nd c. BC

- **Ctesibius** and various other **Greeks of Alexandria** of the period developed and put to practical use various air and water pumps which served a variety of purposes, such as a **water organ**.

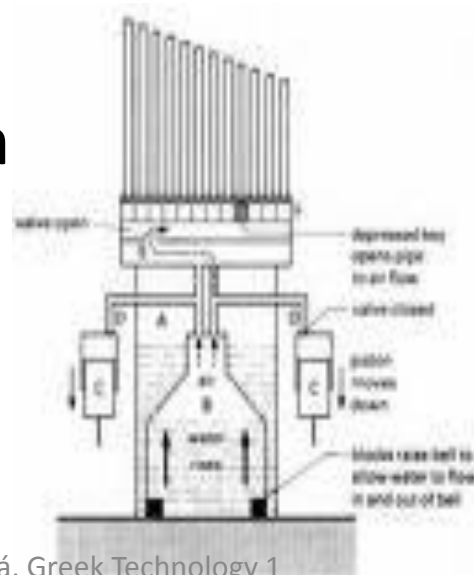

# Analog computers

- ca. 150 BC
- *Antikythera mechanism*

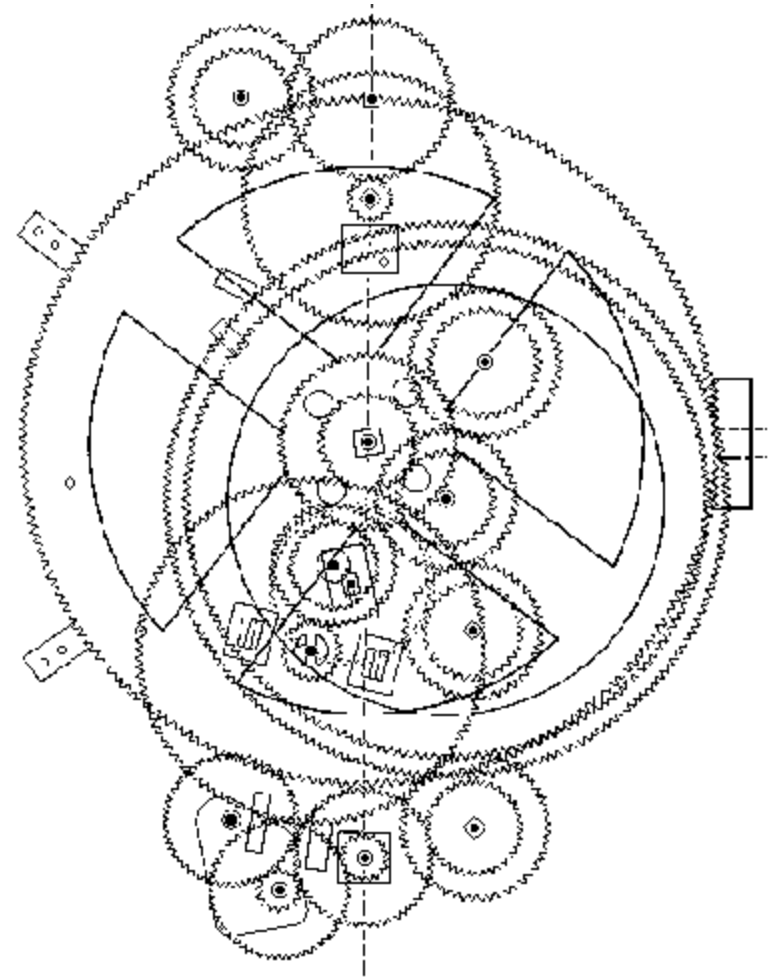



# Automatic doors

ca. 1st c. BC

- **Hero of Alexandria**, a first century BC inventor from Alexandria, Egypt, created automatic doors for a temple with the aid of steam power.

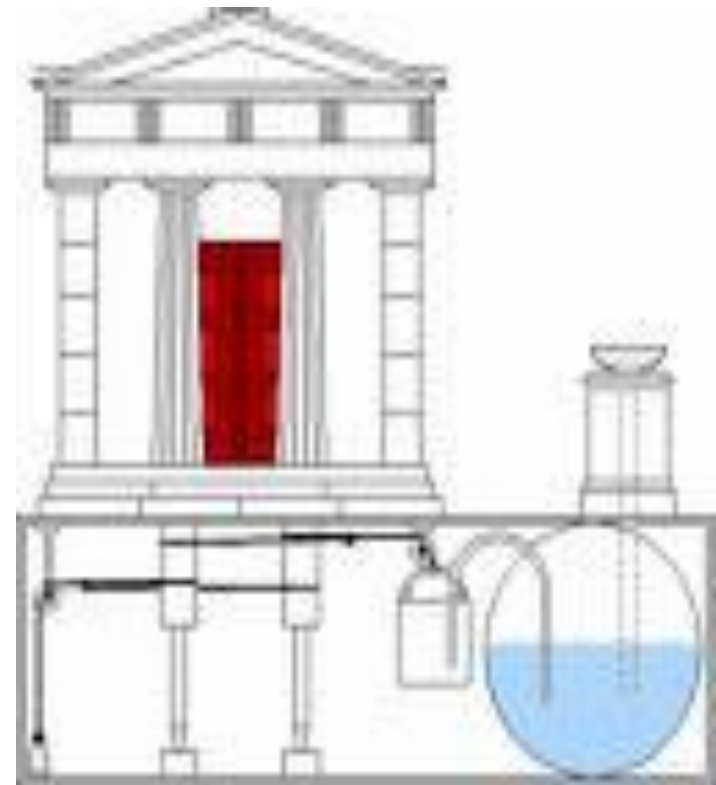
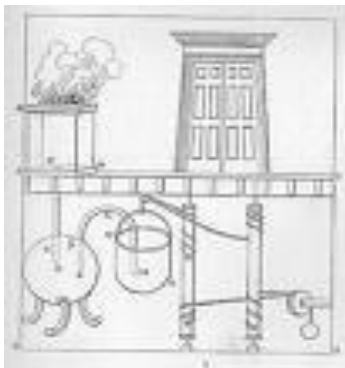

# Wind vane

50 BC

- The **Tower of the Winds** on the Roman *agora* in Athens featured atop a wind vane in the form of a bronze Triton holding a rod in his outstretched hand rotating to the wind blowing.
- Below, its frieze was adorned with the eight wind deities. The 8 m high structure also featured **sundials** and **a water clock** inside dates from around 50 BC.

# Clock tower

50 BC

- Apart from a wind vane the **Tower of the Winds** also featured **eight sundials** arranged around the top of the polygonal structure.
- Recent research has shown that the height of 8 m was motivated by the intention to place the sundials and the wind-vane at a visible height on the Agora, making it effectively an early example of **a clocktower**.



# Chain drive

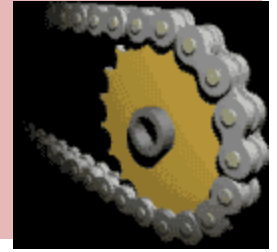

- The oldest known application of a chain drive appears in the **Polybolos**, a repeating crossbow described by the Greek engineer **Philon of Byzantium** (3rd century BC).
- Two flat-linked chains were connected to a windlass, which by winding back and forth would automatically fire the machine's arrows until its magazine was empty. Although the device did not transmit power continuously since the chains "did not transmit power from shaft to shaft", the Greek design marks the beginning of the history of the chain drive since "no earlier instance of such a cam is known, and none as complex is known until the 16th century. It is here that the flat-link chain, often attributed to **Leonardo da Vinci**, actually made its first appearance."

# The earliest known chain drive

- **Polybolos** (reconstruction) described by the Hellenistic writer Philo of Byzantium (3rd century BC).
- The semi-automated **arrow thrower** features the earliest known chain drive.



# Su Song - 1092

- Oldest known illustration of an endless power-transmitting chain drive
- From **Su Song**'s book of 1092 describing his clock tower of Kaifeng





# Chain drive -2

- **The first** continuous power-transmitting chain drive was depicted in the written **horological treatise of the Song Dynasty (960–1279)** Chinese engineer **Su Song(1020-1101 AD)**, who used it to operate the armillary sphere of his astronomical clock tower as well as the clock jack figurines presenting the time of day by mechanically banging gongs and drums. The chain drive itself was given power via the hydraulic works of Su's water clock tank and waterwheel, the latter which acted as a large gear.
- The endless power-transmitting chain drive was invented separately in Europe by **Jacques de Vaucanson** in 1770 for a silk reeling and throwing mill. **J. F. Tretz** was the first to apply the chain drive to the bicycle in 1869.